

50 to 80 W POWER AMPLIFIER DRIVER

DESCRIPTION

μ PC1298V is a integrated monolithic circuit designed for 50 W to 80 W class HiFi audio power amplifier and consists of a input differential amplifier, a predriver circuit, a driver circuit and a over current protection circuit.

FEATURES

- Low Distortion.
0.002 % TYP. ($V_{CC} = \pm 46$ V, $f = 1$ kHz, $A_v = 30$ dB, $P_O = 50$ W, $R_L = 8 \Omega$ with Power Transistor)
0.006 % TYP. ($V_{CC} = \pm 46$ V, $f = 20$ kHz, $A_v = 30$ dB, $P_O = 50$ W, $R_L = 8 \Omega$ with Power Transistor)
- Wide Frequency Band.
900 kHz TYP. (-3 dB)
- Wide Power Band Width.
90 kHz TYP. ($P_O = 40$ W, THD = 0.1 %)

BLOCK DIAGRAM

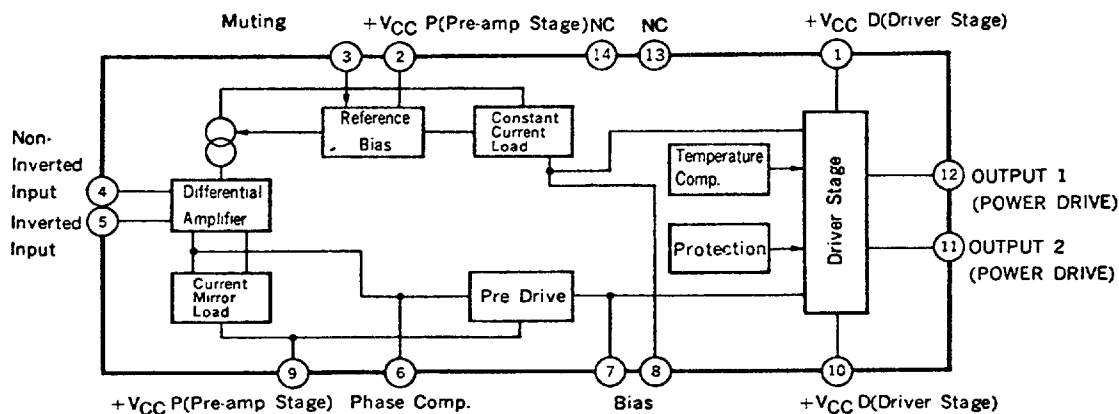

NOTE: The built-in over current circuit protects μ PC1298V and cannot protect external power transistors.

NEC cannot assume any responsibility for any circuits shown or represent that they are free from patent infringement.

ABSOLUTE MAXIMUM RATINGS ($T_a = 25^\circ\text{C}$)

Supply Voltage (Quiescent)	V_{CC1}	± 65	V
Supply Voltage (Operational)	V_{CC2}	± 60	V
Circuit Current	$I_{CC(\text{peak})}$	250	mA
Allowable Package Dissipation	P_D	7.5*	W
Operational Temperature	T_{opt}	-20 to +75	$^\circ\text{C}$
Storage Temperature	T_{stg}	-40 to +150	$^\circ\text{C}$

* 100 x 100 x 2 mm Al heat sink

RECOMMENDED OPERATING CONDITION

Supply Voltage (Operational)	$V_{CC} = \pm 20$ to ± 46 V
Input Bias Resistance	$R_{IN} = 1$ to 50 to 100 $k\Omega$
Power Transistor h_{FE}	$h_{FE} \geq 50$ at $P_O = 80$ W, $R_L = 8 \Omega$, $T_j < 125^\circ\text{C}$
Closed Loop Voltage Gain	$A_v = 26$ to 30 dB
Junction Temperature	$T_j = -20$ to 125°C

ELECTRICAL CHARACTERISTICS ($V_{CC} = \pm 46$ V, $A_v = 30$ dB, Use Standard Test Circuit, $T_a = 25^\circ\text{C}$)

CHARACTERISTIC	SYMBOL	MIN.	TYP.	MAX.	UNIT	CONDITION
Output Offset Voltage	V_{offset}		± 5	± 50	mV	$V_{IN} = 0$
Quiescent Circuit Current	I_{CC}		20	40	mA	$V_{IN} = 0$
Maximum Output Voltage	V_{OM}	25	28		V	THD=0.05%, $f = 20$ Hz to 20 kHz
Open Loop Voltage Gain	A_{vo}	80	95		dB	$V_O = 1.5$ V, $f = 1$ kHz
Output Noise Voltage	V_n		0.07	0.14	mV	$R_G = 10$ $k\Omega$
Rolloff Frequency	f_H		900		kHz	$V_O = 1.5$ V, -3 dB
Supply Voltage Rejection Ratio	SVR	55	70		dB	$R_G = 2.2$ $k\Omega$, $f_{\text{ripple}} = 100$ Hz, $v_{\text{ripple}} = 1$ V _{r.m.s.}

EQUIVALENT CIRCUIT

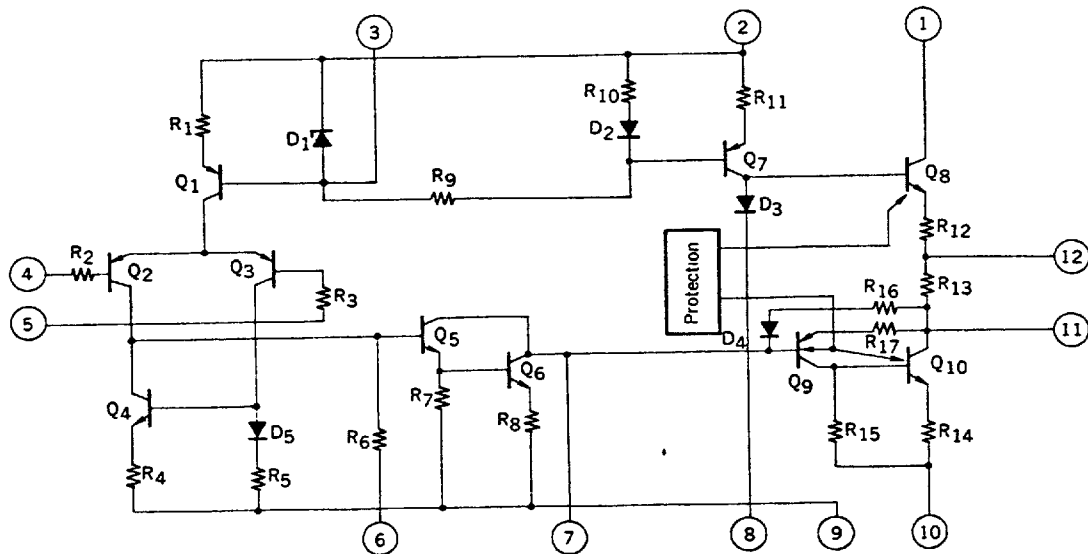

TEST CIRCUIT 1 (I_{CC} , V_{OFF})

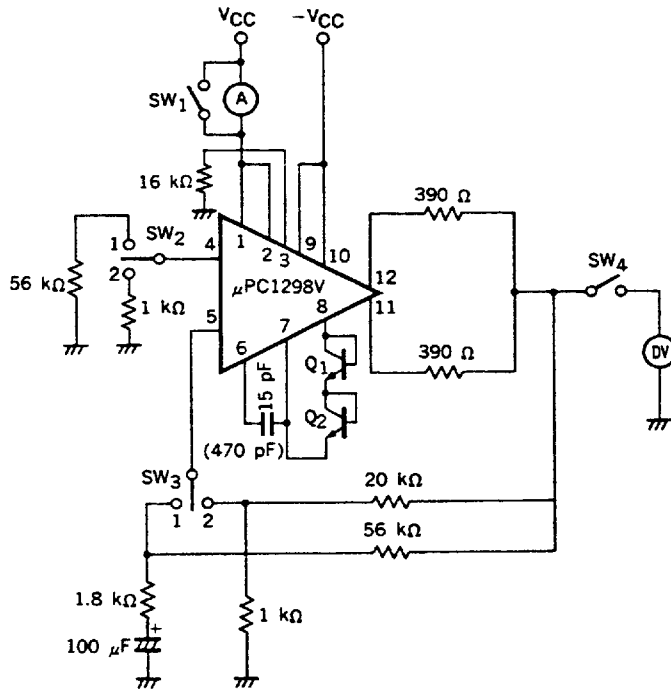

Q1 } 2SC1844F
Q2 }

SWITCH POSITION

	SW ₁	SW ₂	SW ₃	SW ₄
I_{CC}	OFF	2	2	OFF
V_{OFF}	ON	1	1	ON

TEST CIRCUIT 2 (V_{OM}, A_v, A_{vO}, V_{NO}, SVR, PBW)

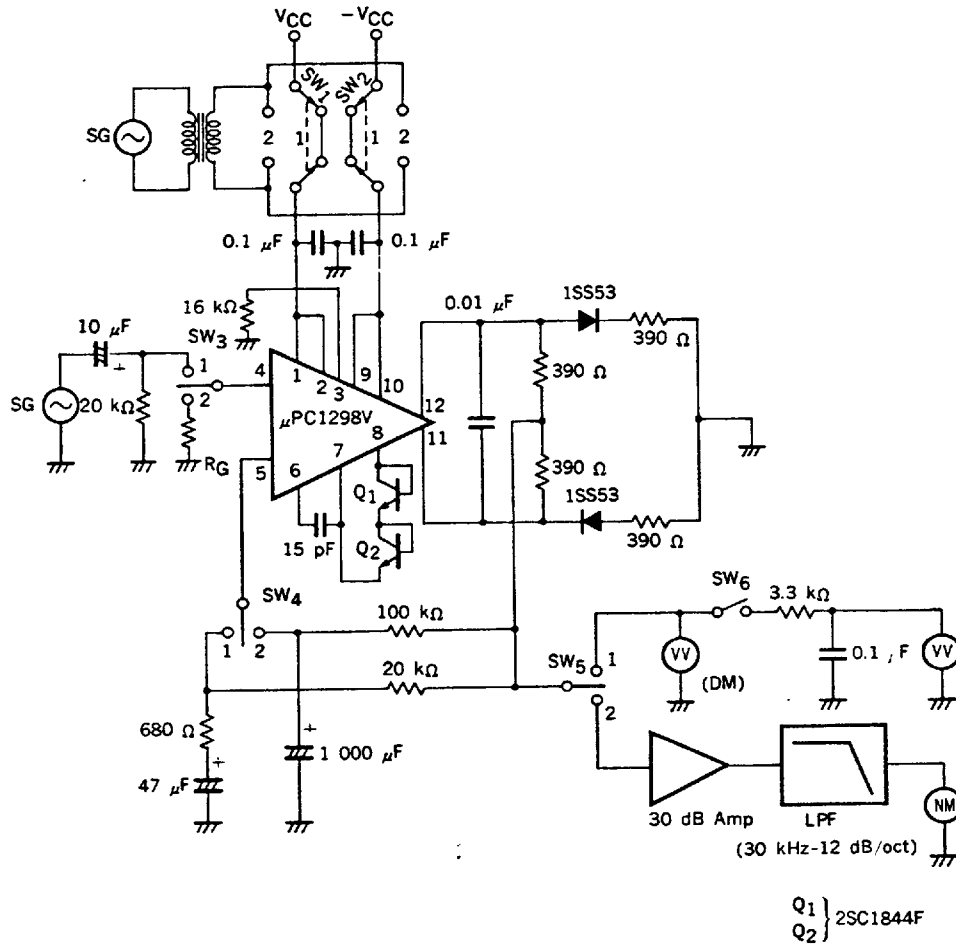

SWITCH POSITION

	SW ₁	SW ₂	SW ₃	SW ₄	SW ₅	SW ₆
V _{OM}	1	1	1	1	1	OFF
A _v	1	1	1	1	1	OFF
A _{vO}	1	1	1	2	1	OFF
V _{NO}	1	1	2	1	2	OFF
SVR	2/1	1/2	2	1	1	ON
PBW	1	1	1	1	1	OFF

APPLICATION CIRCUIT

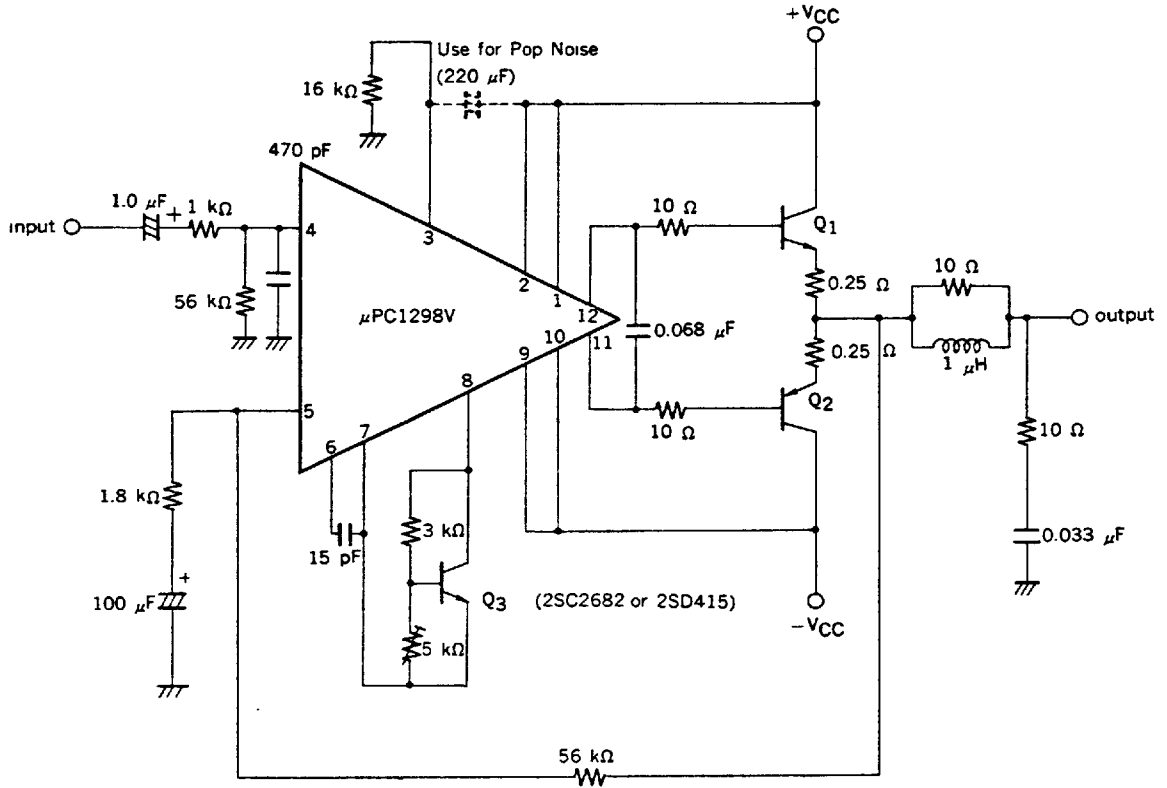

RECOMMENDED POWER TRANSISTOR

P _O	25 to 40 W	45 to 55 W	50 to 70 W	70 to 80 W
Q ₁	2SD1288 2SD2013	2SD1289 2SD1977	2SC3012 2SC4267	2SC2987 2SC2987A 2SC4268
Q ₂	2SB965 2SB1336	2SB966 2SB1315	2SA1232 2SA1631	2SA1227 2SA1227A 2SA1632

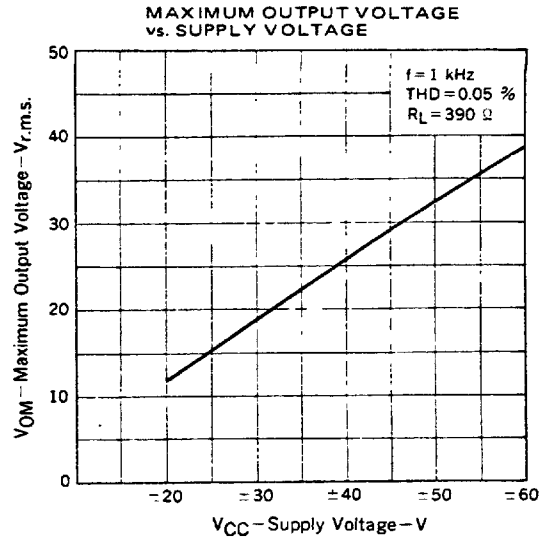
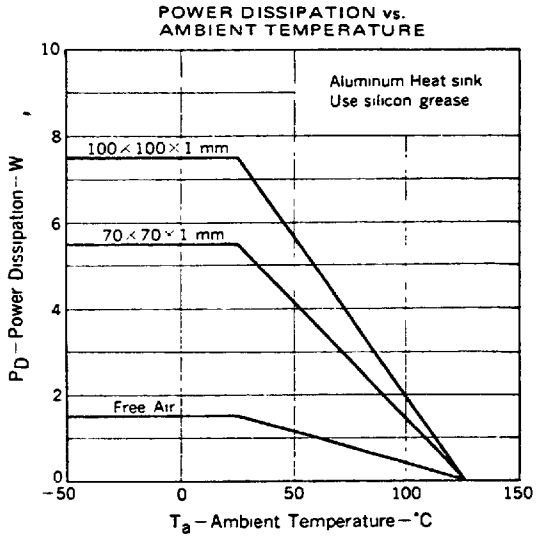

OPEN LOOP VOLTAGE GAIN, SUPPLY VOLTAGE REJECTION RATIO, OUTPUT NOISE VOLTAGE, CIRCUIT CURRENT, OUTPUT OFFSET VOLTAGE vs. SUPPLY VOLTAGE

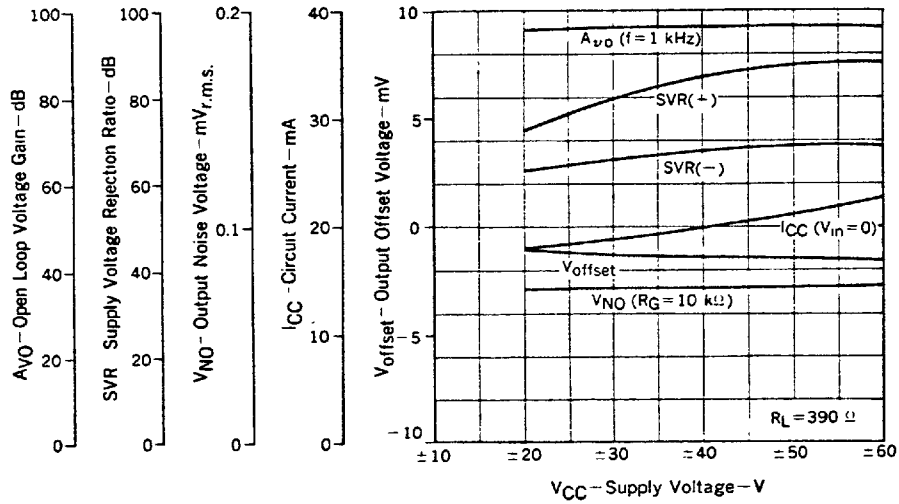

OPEN LOOP VOLTAGE GAIN, OUTPUT NOISE VOLTAGE, CIRCUIT CURRENT, OUTPUT OFFSET VOLTAGE vs. AMBIENT TEMPERATURE

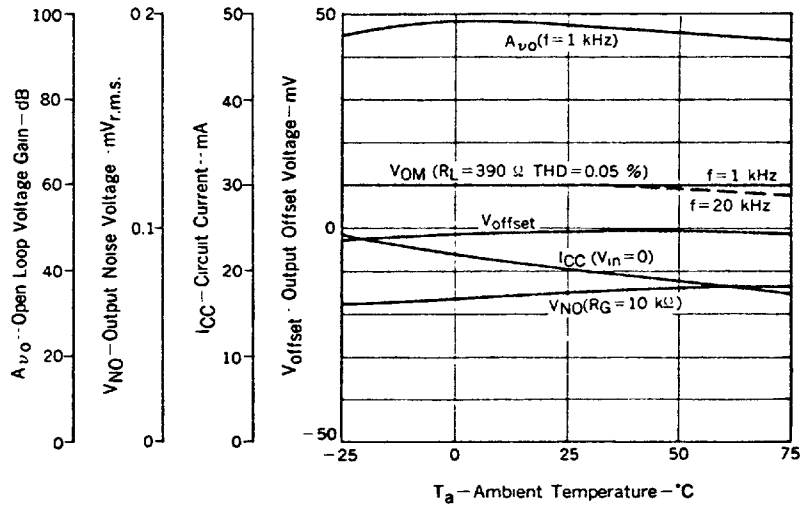

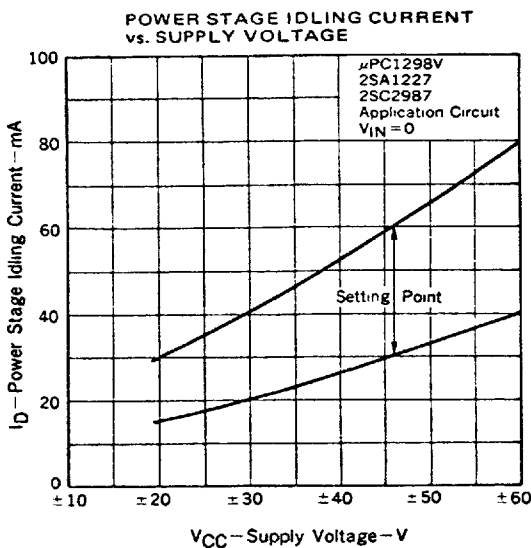
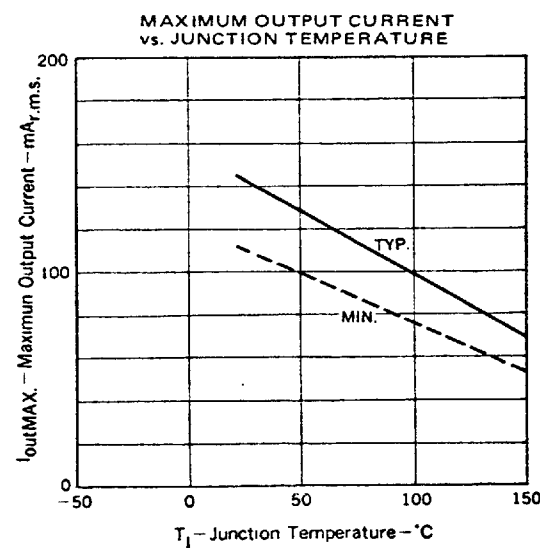
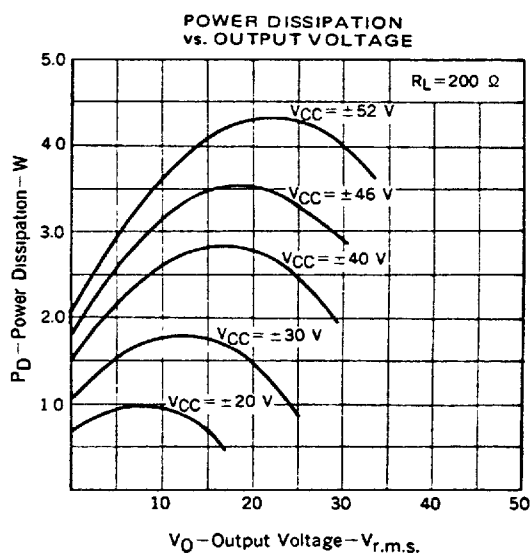
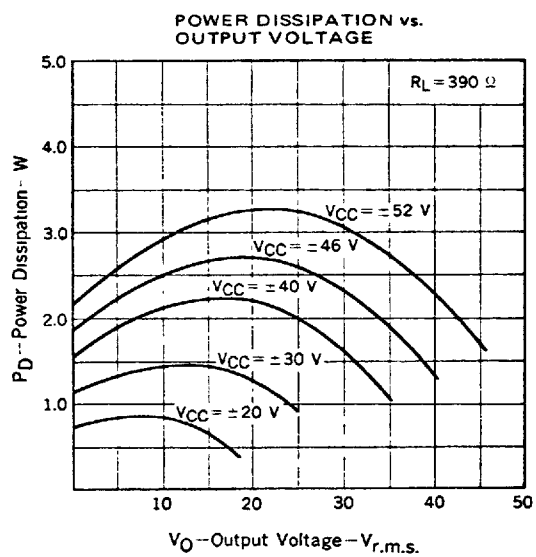
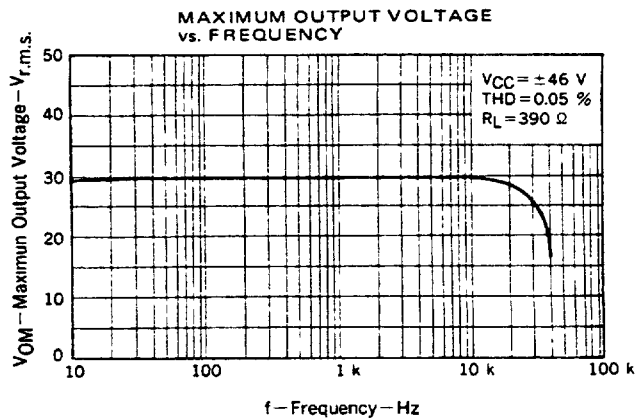
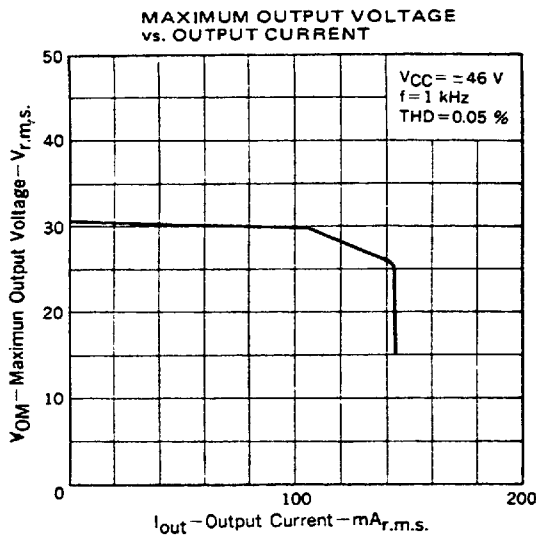

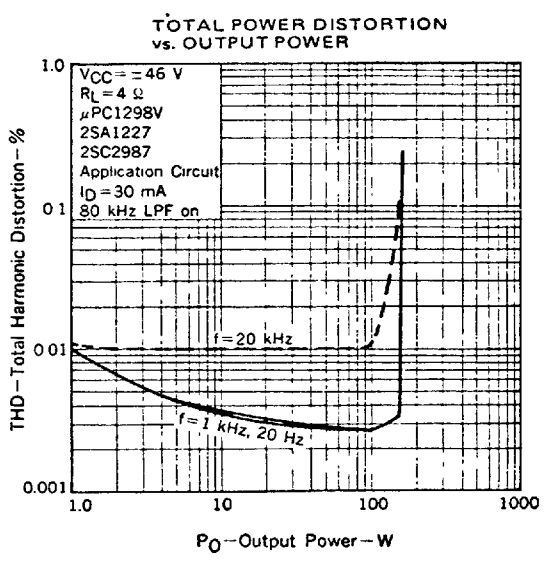
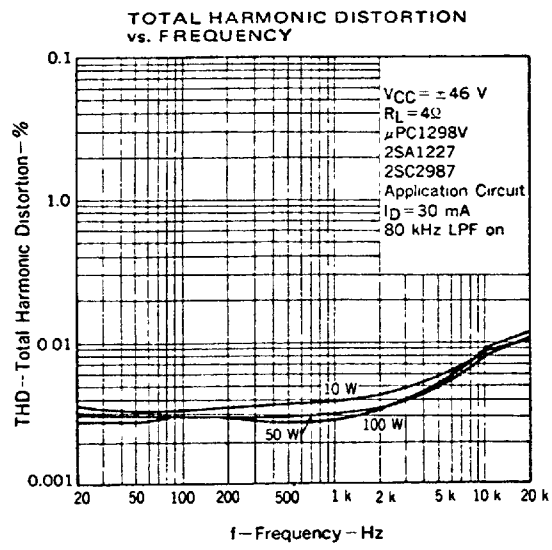
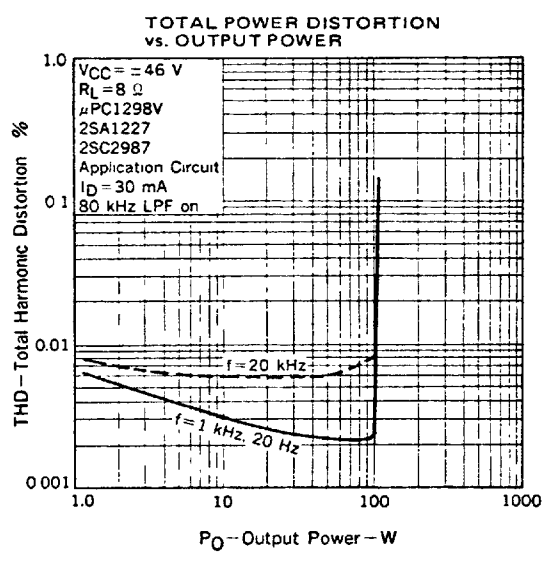
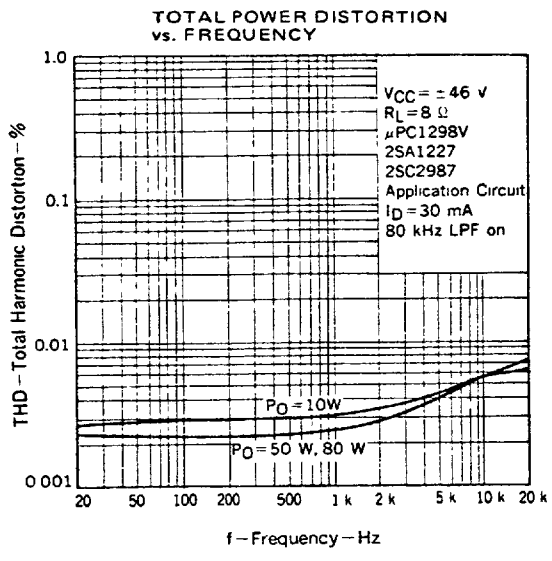
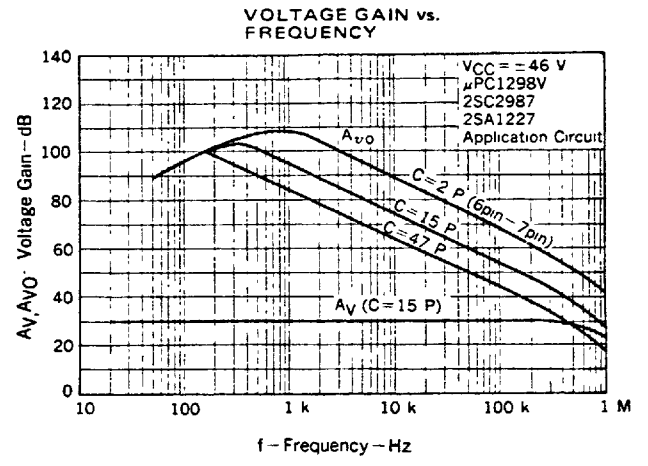
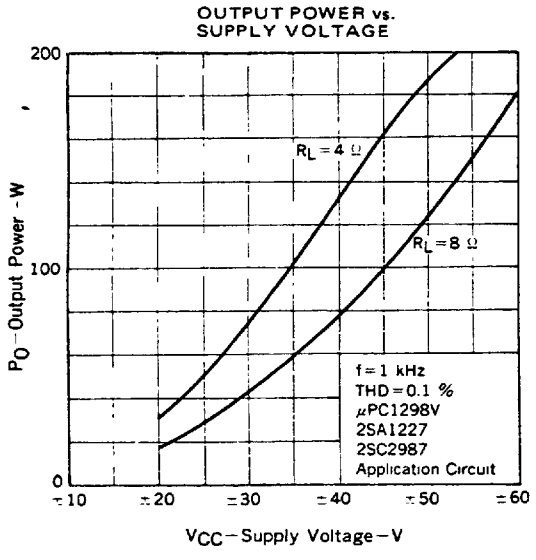

PACKAGE DIMENSIONS (Unit : mm)

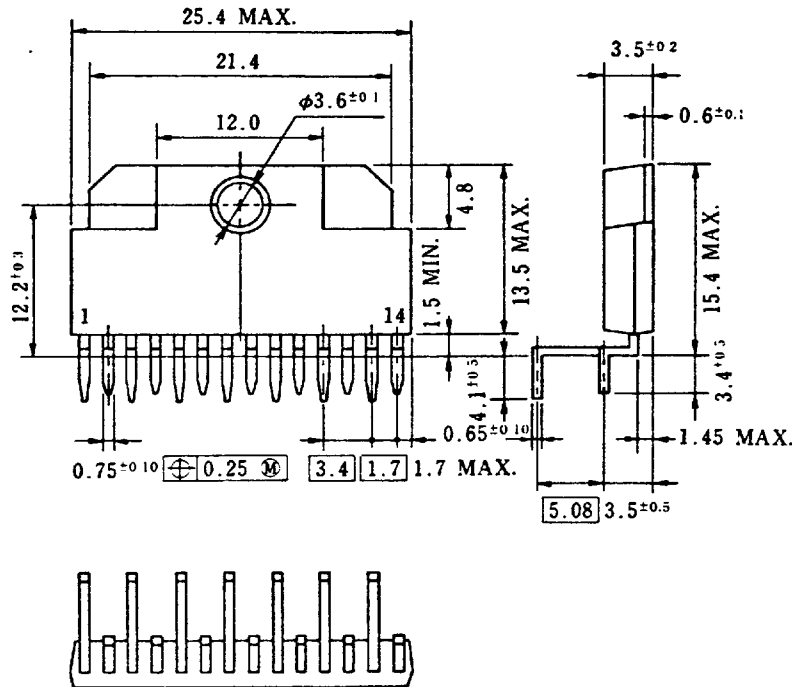

PIN CONNECTION DIAGRAM

PIN No.	PIN CONNECTION
1	+V _{CCD} (for Driver)
2	+V _{CCP} (for Preamp)
3	MUTING
4	INPUT
5	NFB
6	PHASE COMP
7	BIAS
8	BIAS
9	-V _{CCP} (for Preamp)
10	-V _{CCD} (for Driver)
11	LOWER OUTPUT
12	UPPER OUTPUT
13	NC
14	NC